

Supported by:



5TH INDIAN TRADE FAIR 2012

4TH TO 6TH SEPTEMBER 2012

OMAN INTERNATIONAL EXHIBITION CENTRE, MUSCAT, SULTANATE OF OMAN

Supported by:



Supported by:



Supported by:



Supported by:



Supported by:



Supported by:



Supported by:



Supported by:



Supported by:



Supported by:

**OPTIONAL FURNITURE ITEMS****25.01.12**

ITEM	SIZE - CM	ITEM NO.	UNIT PRICE
	L X W X H		RO.BZS
ASHTRAY (DESK TOP)		26	2.000
ASHTRAY (FREE STANDING)		25	9.000
BAG HOLDER		1	2.500
BANNER FRAME			12.500
BAR - 1m/2m/3m			4.000
CARPET TILES - Per sq.m.	50 x 50	3	4.000
CHAIR (PLASTIC)		5	3.000
COUNTER (FREE MODEL WITH DOOR)	103 X 53 X 90	2	20.000
COUNTER (FREE MODEL)	103 X 53 X 90	4	14.500
COUNTER (HIGH MODEL)	103 X 53 X 105	7	14.500
COUNTER (LOW MODEL)	94 X 45 X 76	9	11.000
EXHIBIT BASE (BIG)	103 X 103 X 60	6	19.000
EXHIBIT BASE (SMALL)	103 X 103 X 30	8	12.500
FIRE EXTINGUISHER		27	9.000
GARMENT RACK		10	19.000
GLASS SHOW CASE - FULL GLASS	103 X 53 X 100		22.500
GLASS SHOW CASE - PEDESTAL	103 X 53 X 215		44.000
GLASS SHOW CASE/SHOW CASE FREE MODEL	103 X 53 X 105	11/13	19.000
LITERATURE HOLDER		15	11.500
LITERATURE HOLDER (FREE STANDING)	140 X 70.5	17	9.000
NET - 3m X 3m			4.000
SHELF (FLAT) - Dead Load 10 Kg.	100 X 30	12	3.000
SHELF (LONG) - Dead Load 10 Kg.	200 x 10	19	3.000
SHELF (SLOPING - ADJUSTABLE) - Dead Load 5 Kg.	100 x 30	14	4.000
TABLE (FOLDING TYPE)	220 X 80 X 74.8	16	9.000
TABLE (SQUARE TYPE)	80 X 80 X 73	18	6.000
TELEPHONE		20	38.000
WALL DISPLAY PANEL	103 X 60	21	9.000
WALL PANEL (HORIZONTAL)	300 X 100	23	19.000
WALL PANEL (VERTICAL)	250 X 103	22	6.500
WASTE BASKET		24	2.500
ACCESSORIES			
* Hammer Head Screw		28	1.000
* Ring Screw		29	1.000
* Hook Screw		30	1.000
* Chain		31	1.500

Venue:



Organised by:

Silver Star Corporation L.L.C.

PO Box 1075, Ruwi, Postal Code 112, Sultanate of Oman

Note: RO. 1 = U.S. \$ 2.59710

Supported by:

5th INDEXPO
MUSCAT 20125TH INDIAN TRADE FAIR 2012
4TH TO 6TH SEPTEMBER 2012

OMAN INTERNATIONAL EXHIBITION CENTRE, MUSCAT, SULTANATE OF OMAN

Supported by:



Supported by:

**OPTIONAL ELECTRICAL ITEMS**

25.01.12

DESCRIPTION	CONSUMPTION	UNIT PRICE
		RO.BZS
BUILT STANDS		
SPOT LIGHT	100 W	5.000
TUBE LIGHT	40 W	6.500
13 amp DOUBLE SOCKET 240V	0.8 kW Max. use	6.000
13 amp DOUBLE SOCKET 240V	0.8 kW Max. use 24 hours	9.000
13 amp DOUBLE SOCKET 240V	3 kW Max. use	19.000
13 amp DOUBLE SOCKET 240V	3 kW Max. use 24 hours	22.500
10 amp 3 phase (without DB) 415V	5.75 kW Max. use	41.500
15 amp 3 phase (without DB) 415V	8.6 kW Max. use	50.000
30 amp 3 phase (without DB) 415V	17 kW Max. use	81.500
60 amp 3 phase (without DB) 415V	34 kW Max. use	142.500
100 amp 3 phase (without DB) 415V	57 kW Max. use	267.500
DISTRIBUTION BOARD	100 A TPN	25.000
HALOGEN LIGHT FITTING	500 W	9.000
HALOGEN LIGHT FITTING	1000 W	19.000
BARE SPACE		
SPOT LIGHT	100 W	12.500
TUBE LIGHT	40 W	12.500
13 amp DOUBLE SOCKET 240V	3 kW Max. use	22.500
13 amp DOUBLE SOCKET 240V	3 kW Max. use 24 hours	27.000
10 amp 3 phase (without DB) 415V	5.75 kW Max. use	49.500
15 amp 3 phase (without DB) 415V	8.6 kW Max. use	60.000
30 amp 3 phase (without DB) 415V	17 kW Max. use	97.500
60 amp 3 phase (without DB) 415V	34 kW Max. use	165.500
100 amp 3 phase (without DB) 415V	57 kW Max. use	320.000
DISTRIBUTION BOARD	100 A TPN	30.000
HALOGEN LIGHT FITTING	500 W	31.500
HALOGEN LIGHT FITTING	1000 W	50.000

Supported by:



Supported by:



Supported by:



Supported by:



Supported by:



Supported by:



Supported by:



Supported by:



Venue:



Organised by:

Silver Star Corporation L.L.C.

PO Box 1075, Ruwi, Postal Code 112, Sultanate of Oman

Note: RO. 1 = U.S \$ 2.59710

Optional Furniture

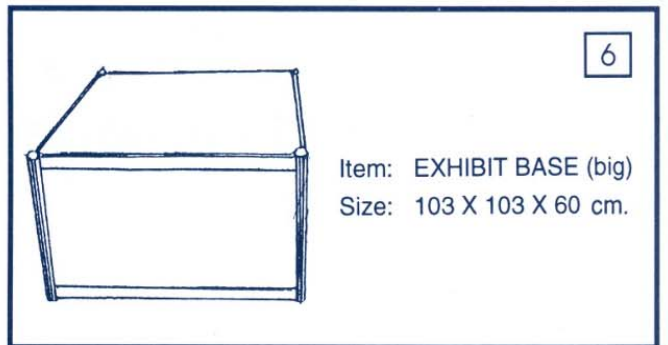
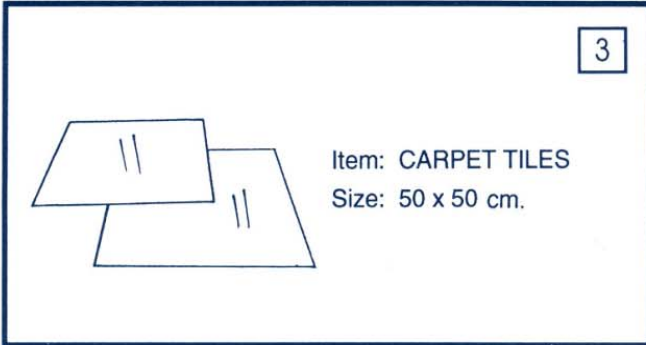

Optional Furniture

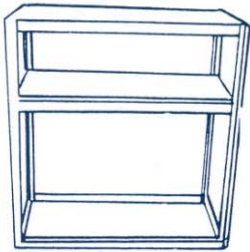

11

Item: GLASS SHOWCASE
Size: 103 X 53 X 105 cm.



12

Item: SHELF (flat)
Size: 100 X 30 cm.
Dead Load - 10 Kg.

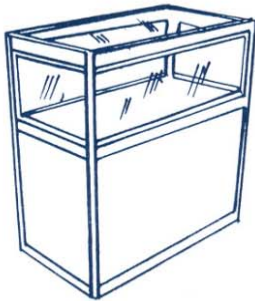

13

Item: GLASS SHOWCASE
(free model)
Size: 103 X 53 X 100 cm.

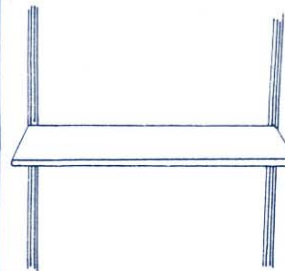

14

Item: SHELF
(slope-adjustable)
Size: 100 X 30 cm.
Dead Load - 5 Kg

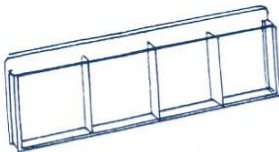

15

Item: LITERATURE HOLDER



16

Item: TABLE (folding type)
Size: 220 X 80 X 74.8 cm.

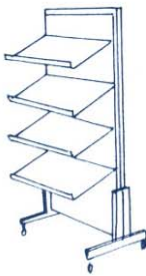

17

Item: LITERATURE RACK
(free standing)
Size: 140 X 70.5 cm.



18

Item: TABLE (square type)
Size: 80 X 80 X 73 cm.

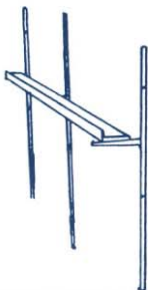

19

Item: SHELF (long)
Size: 200 X 10 cm.
Dead Load - 10 Kg.



20

Item: TELEPHONE

Optional Furniture

